

L170 SERIES

COMPACT FLOAT SWITCHES FOR HIGH TEMPERATURES & PRESSURES

DESCRIPTION

The L170 Series Compact Level Switches feature a Buna-N or stainless steel float for higher heat and pressure capabilities. Designed for low-cost, high-volume use, the L170 vertical switches are best suited in shallow and restricted tank spaces. Their durable brass and stainless steel construction also allow for installations in several harsh and corrosive environments. The L175 features a larger stainless steel float that will operate in fluids with specific gravities as low as 0.70. Alternatively, the L177 is equipped with a reinforced float that will withstand pressures up to 600 PSIG. All stainless steel L170 models are FDA compliant with food contact regulations and provide an ideal choice for use in food and beverage equipment.







PRINCIPLE OF OPERATION

A hermetically-sealed reed switch is actuated by an internal magnet within the float. As the float rises and falls with the liquid level, the magnetic field passes the switch encapsulated within the stem and results in a switch state change.

KEY FEATURES

- Ideal For Shallow Tanks
- Single-Stage Vertically-Mounted
- Broad Media Capability
- Interchangeable NO or NC Operation By Float Inversion
- SPST 50 VA Switch (Standard)

APPLICATIONS

-  Food Processing Equipment
-  Food Warmers
-  Food Dispensing Systems
-  Storage Tanks
-  Fuel Dispensing Systems
-  Humidity Control Equipment

SPECIFICATIONS

SERIES	MOUNT	STEM/FLOAT	SG*	TEMPERATURE	PRESSURE
L170	1/8" NPT	Brass/Buna	0.63	-40 to +180 °F (-40 to +82.2 °C)	150 PSIG (10.3 bar)
L170	1/8" NPT	Stainless Steel/Buna	0.63	-40 to +180 °F (-40 to +82.2 °C)	150 PSIG (10.3 bar)
L175	1/8" NPT	Brass/Stainless Steel	0.69	-40 to +300 °F (-40 to +148.9 °C)	100 PSIG (6.9 bar)
L175	1/8" NPT	Stainless Steel	0.69	-40 to +300 °F (-40 to +148.9 °C)	100 PSIG (6.9 bar)
L176	1/8" NPT	Brass/Stainless Steel	1.00	-40 to +300 °F (-40 to +148.9 °C)	300 PSIG (20.7 bar)
L176	1/8" NPT	Stainless Steel	1.00	-40 to +300 °F (-40 to +148.9 °C)	300 PSIG (20.7 bar)
L177	1/8" NPT	Brass/Stainless Steel	0.96	-40 to +300 °F (-40 to +148.9 °C)	600 PSIG (41.4 bar)
L177	1/8" NPT	Stainless Steel	0.96	-40 to +300 °F (-40 to +148.9 °C)	600 PSIG (41.4 bar)
L178	1/8" NPT	Brass/Stainless Steel	0.86	-40 to +300 °F (-40 to +148.9 °C)	275 PSIG (18.9 bar)
L178	1/8" NPT	Stainless Steel	0.86	-40 to +300 °F (-40 to +148.9 °C)	275 PSIG (18.9 bar)



DIMENSIONS

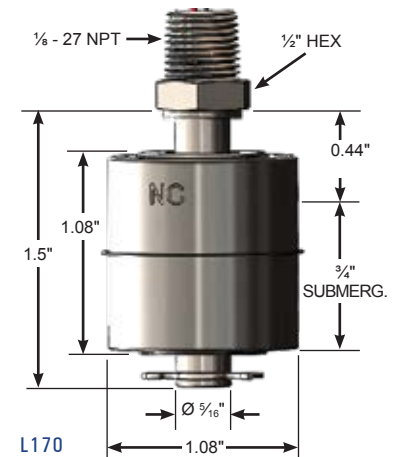

*SG refers to the recommended minimum liquid specific gravity.